



Soundproofing for CLT by Stora Enso

Contents

1.	Introduction	4
2.	Determining the performance of sound insulation	5
2.1.	Measuring sound insulation	5
2.2.	Sound insulation parameters	5
2.2.1.	Airborne sound parameters:	5
2.2.2.	Impact sound parameters:	5
2.3.	Rating measured curves	6
2.4.	Spectrum adaptation values	7
2.5.	Descriptors and requirements in European countries	7
2.5.1.	Swedish requirements	7
2.5.2.	Sound insulation at low frequencies	8
3.	Sound insulation of building components	9
3.1.	Single-layer components	9
3.2.	Mass formula for CLT by Stora Enso	9
3.3.	Orthotropic plates	10
3.4.	Multi-layer components.....	11
3.5.	Prediction model for airborne sound insulation of CLT-walls with ETICS	12
3.6.	Sound insulation of composed building components	12
4.	Sound insulation of CLT components.....	14
4.1.	Floor structures	14
4.2.	Wall structures	15
4.2.1.	Partition walls.....	15
4.2.2.	External walls.....	16
4.2.3.	Internal walls.....	17
1.1.	Roof structures.....	18
1.1.1.	Examples for roof structures:.....	18
5.	Sound transmission in buildings	20
	Bibliography	20
	Annex A: Comparison of minimum requirements in 35 European countries [1].....	21
	Annex B: Planning principles related to the requirements for elastic bearings [2]	23



DISCLAIMER: It should be noted that this fact sheet on soundproofing is merely intended to support the user. Stora Enso Wood Products does not assume any responsibility for the accuracy or completeness of this document.

1. Introduction

Providing adequate protection from noise disturbance is an important factor for ensuring a sense of well-being in buildings. Therefore, sound insulation should be a top priority during the building planning stage.

Sound is defined as mechanical kinetic energy which is transmitted through elastic media by pressure and density fluctuations. Thus, sound is the audible vibration of gases, fluids and solids. After identifying the source of noise to which a component is exposed, acoustic design distinguishes between airborne and structure-borne sound.

- **Airborne sound** – air sound waves cause components to vibrate, and these vibrations are transmitted to adjacent rooms in the building. Sources of airborne sound include traffic, voices or music.
- **Structure-borne sound** – the sound of walking, banging, scraping furniture, etc. is transmitted to components and radiated as airborne sound into adjacent rooms. **Impact sound** is particularly relevant to acoustic design.

Normative sound insulation requirements ensure that persons with normal sensitivities are provided with sufficient protection against noise from outside the building, from other parts of the same building and from adjacent buildings. The role of acoustic design is to reduce disturbing noise in the building to a defined degree.

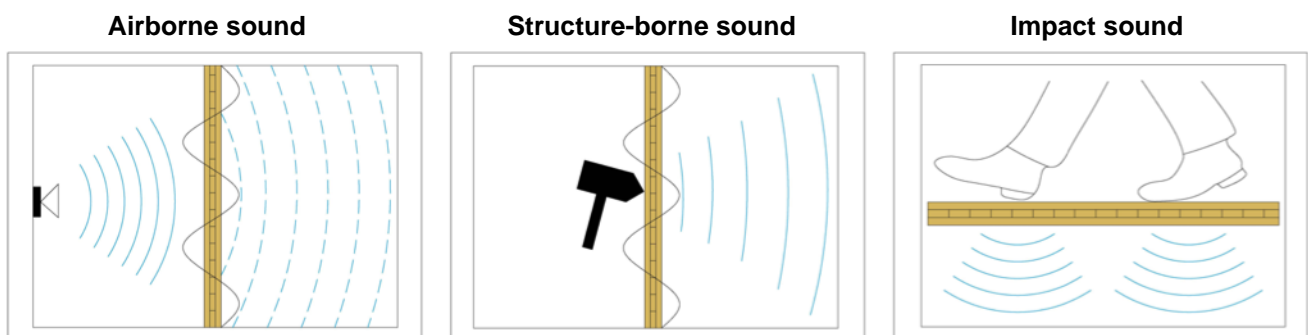

2. Determining the performance of sound insulation

2.1. Measuring sound insulation

To determine the sound insulation performance of a building component, a source room is exposed to a source of noise (in a test facility or a building). The incoming sound is then measured in a receiving room.

With airborne sound measurements, the source of noise is a loudspeaker and the sound reduction index R of a component results from the level difference between the source room and the receiving room (the higher the value, the better the sound insulation).

With impact sound measurements, on the other hand, the source of noise is a standard tapping machine and the impact sound pressure level L measured in the receiving room expresses the performance of the structure's soundproofing (the lower the level, the better the soundproofing).

In principle, the extended frequency range (50 Hz to 5000 Hz) is measured, however only the range between 100 Hz and 3150 Hz is taken into account to calculate the single-number value. This range is divided into five octave bands (frequency doubling) or into 16 one-third-octave bands (three thirds make up one octave).

2.2. Sound insulation parameters

The parameters used to express sound insulation are listed in the individual parts of the ISO 10140 and ISO 16283 series of standards and the procedures for rating single-number values are described in standards ISO 717-1 and 717-2:

2.2.1. Airborne sound parameters:

- **Sound reduction index R**

$$R = 10 \log \frac{W_1}{W_2}$$

Ten times the common logarithm of the ratio of the sound power W_1 on a test specimen to the sound power W_2 , transmitted through the specimen.

If sound pressure is measured, the sound reduction index is calculated as follows:

$$R = L_1 - L_2 + 10 \log \frac{S}{A}$$

- **Apparent sound reduction index R'**

A prime [$'$] shows that a value is measured inside the building and sound transmission through flanking components is included.

- **Standardised sound level difference D_{nT}**

$$D_{nT} = L_S - L_E + 10 \log \frac{T}{T_0} \text{ corresponding to the reference value of the reverberation time of 0.5 s.}$$

- **Standard sound level differences have the following relationship with the structural elements sound reduction index:**

$$D_n = R' + 10 \lg \frac{10}{S}$$

$$D_{nT} = R' + 10 \lg \frac{0,32 V}{S}$$

2.2.2. Impact sound parameters:

- **Normalised impact sound pressure level L_n**

$$L_n = L + 10 \log \frac{A}{A_0} \text{ corresponding to the reference absorption area of 10 m}^2.$$

Similarly to the sound reduction index, the normalised impact sound pressure level can also be entered as a building site value ($L'_{n,w}$).

- **Standardised impact sound pressure level $L'_{n,T}$**

$$L'_{nT} = L - 10 \log \frac{T}{T_0} \text{ corresponding to a reference value of the reverberation time of 0.5 s.}$$

- **The standardised and normalised impact sound pressure levels have the following relationship:**

$$L'_{nT} = L'_n - 10 \log 0,032 * V$$

2.3. Rating measured curves

In practice it is desirable to express the transmission loss of an element by a single-number value in order to improve the comparison of data. To determine this value, the measured curves are weighted with reference curves, defined in ISO 717, part 1 for airborne sound and part 2 for impact sound.

When performing this evaluation in accordance with EN ISO 717, the reference curve is shifted towards the measured curve until the sum of the unfavourable deviations is as large as possible, however not more than 32 dB (on average no more than 2 dB per one-third octave band). Favourable deviations are not taken into account. The single-number value is now the reference curve value at 500 Hz.

The additional “w”, which stands for “weighted” (e.g. R_w or $D_{nT,w}$), indicates that this single-number rating is evaluated according to EN ISO 717.

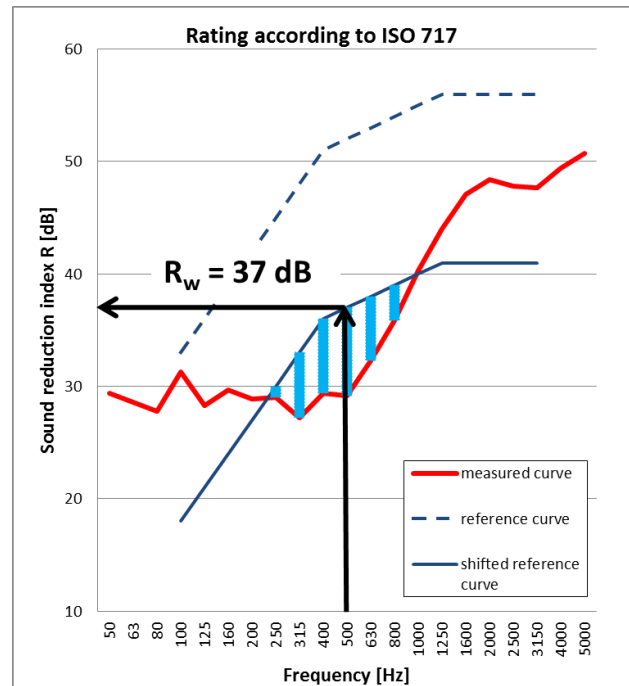

Single-number values from EN ISO 717: 2013			
	airborne sound	impact sound	
Soundproofing of components	R_w	$L_{n,w}$	Shows the test bench situation. Sound transmission through the partition assembly only.
Soundproofing between rooms	R'_w $D_{nT,w}$	$L'_{n,w}$ $L'_{nT,w}$	Shows the building site situation. Sound transmission through the separating component and flanking components.
Spectrum adaptation values	C C_{tr}	C_I	spectrum C: residential noise spectrum C_{tr}: traffic noise spectrum C_I: impact sound

2.4. Spectrum adaptation values

Calculating single-number values does not always give a sufficiently clear picture of the acoustic strengths and weaknesses of building components (different curve progressions can result in identical single-number values [see illustration]) and residential or traffic noise is not sufficiently taken into account. For this reason, spectrum adaptation values have been included in EN ISO 717:1996 to complement the single-number ratings, and are already being used in certain European countries. This complementary information enables greater account to be taken of special sound spectra:

Airborne sound:

- C for residential noise
- C_{tr} for traffic noise

Impact sound:

- C_i for walking noise

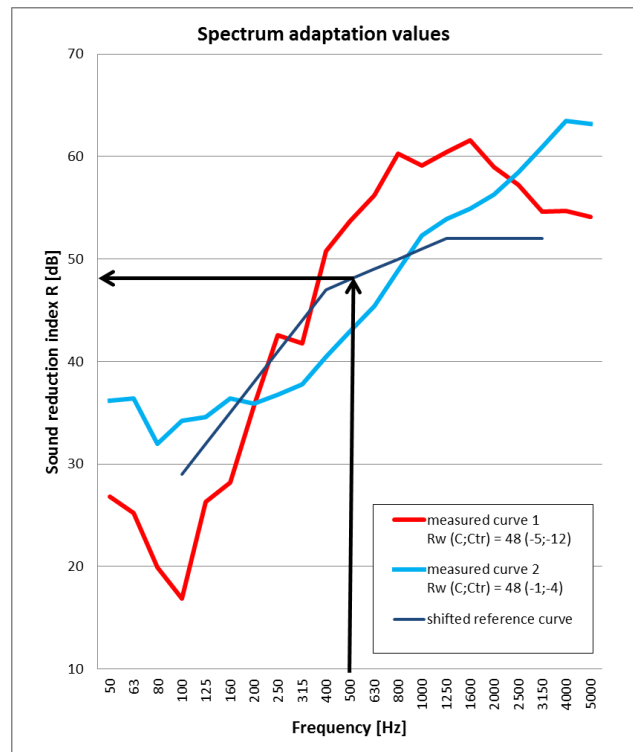

Spectrum adaptation values can also be identified for special frequency ranges of less than 100 Hz or more than 3150 Hz (e.g. C₅₀₋₃₁₅₀ or C_{i,50-2500}).

2.5. Descriptors and requirements in European countries

The appropriate standards use various different expressions to specify sound insulation performance. This means that in 35 European countries, seven different descriptors to specify airborne sound insulation and five different descriptors to specify impact sound insulation are currently used. Eight countries have introduced spectrum adaptation values with one country introducing spectrum adaptation values from 50 Hz. The difference between the minimum requirements for residential buildings is 10 dB for airborne sound and 20 dB for impact sound. Scotland and Austria have the strictest requirements and five countries currently have no standard soundproofing requirements at all. [1]

A comparison of the minimum requirements for airborne and impact sound for residential buildings and terraced houses in 35 European countries was published in [1] and can be found in the form of a table in the annex. Detailed requirements and special regulations can be found in the respectively valid national standards and building regulations.

2.5.1. Swedish requirements

So far, Sweden is the only European country that has introduced low-frequent spectrum adaptation values from 50 Hz on in their building code. The used values are $D_{nT,w} + C_{50-3150}$ (abbreviated as $D_{nT,w,50}$) for airborne sound and $L'_{nT,w} + C_{150-2500}$ (abbreviated as $L'_{nT,w,50}$) for impact sound.

The Swedish building code prescribes the following minimum requirements for building acoustics in new built residential buildings:

- Airborne sound insulation between dwellings: $D_{nT,w} + C_{50-3150} \geq 52$ dB
- Impact noise insulation between dwellings: $L'_{nT,w} + C_{150-2500} \leq 56$ dB

In addition to the minimum requirements from the building code also Sound insulation Classes have been introduced in Swedish Standard SS 25267:

Should only be used in cases where the minimum requirements cannot be fulfilled

	Airbourne sound $D_{nT,w} + C_{50-3150}$	Impact sound $L'_{nT,w} + C_{150-2500}$	
Class A	≥ 60	≤ 48 dB	Highest acoustic performance
Class B	≥ 56	≤ 52 dB	Recommended for new buildings
Building code	≥ 52	≤ 56 dB	Minimum requirements from building code
Class D	≥ 48	≤ 62 dB	Should only be used in cases where the minimum requirements cannot be fulfilled

2.5.2. Sound insulation at low frequencies

The fact that sound transmission is considered from 50Hz on requires new approaches when designing timber constructions. Common measures to improve sound insulation, like a suspended ceiling or a decoupled installation layer does not necessarily lead to a better sound insulation at low frequencies and can in fact reduce the overall level of sound insulation of a building component. The reason for this reduction is the mass-air resonance between the load bearing structure and the additional layers, which is often in the range between 50Hz and 100Hz and leads to a higher sound transmission in this frequency range.

The picture on the right hand side shows a comparison of the impact sound pressure levels of CLT floor structures 1 with a visible CLT bottom view (red line) and structure 2 with a suspended ceiling (blue line). While the suspended ceiling brings advantages at middle and high frequencies, the sound insulation shows a dip at low frequencies. In this case the suspended ceiling reduces the impact sound pressure Level $L_{n,w}$ for 5dB (from 41 to 36 dB) but when considering also spectrum adaption values from 50Hz, the overall value $L_{n,w} + C_{150-2500}$ is deteriorates by 3 dB from 47 dB to 50 dB.

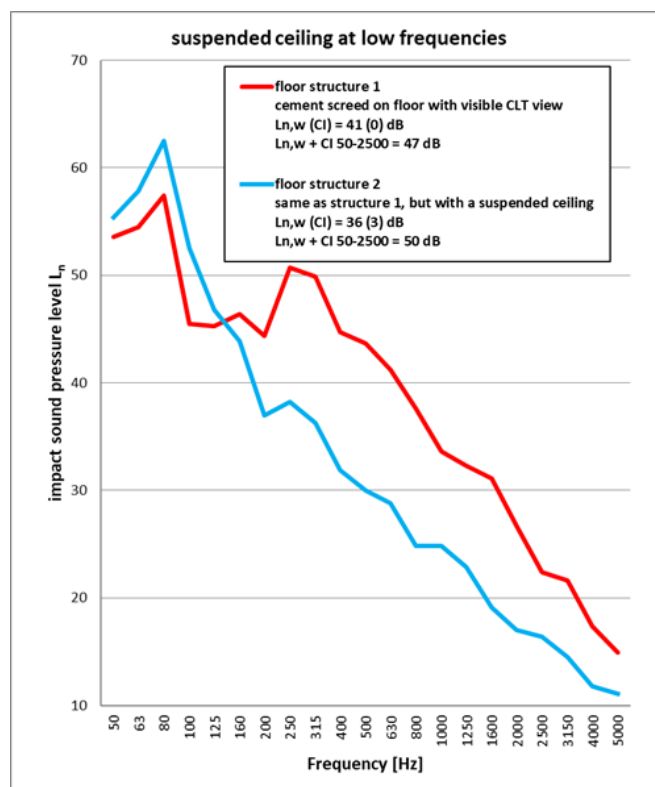

To get better results at low frequencies, with cladded CLT structures, the suspension can be increased to 200mm or the gypsum board can be attached directly, without any suspension, to the CLT.

3. Sound insulation of building components

3.1. Single-layer components

3.1.1. Berger's mass law

The sound insulation of single-layer solid components is primarily determined by the mass of the components. "Acoustic single-layer" components are those that have points of mass that do not change in relation to each other when the component vibrates (they vibrate as a whole unit). The sound reduction index of such structures can be approximately calculated using Berger's mass law:

$$R = 20 \lg \frac{f \cdot m'}{130} [dB]$$

which dictates that sound insulation depends on surface-based mass m' and frequency f . Doubling the mass increases sound insulation by 6 dB. High-pitched sounds are attenuated more effectively than low-pitched sounds, therefore, a noise which penetrates a component will sound duller than the source of noise itself.

3.1.2. Coincidence effect

Sound insulation is impaired where there are resonant frequencies and coincidence effects, thus upsetting the prediction of Berger's mass law. Noise emissions increase in the frequency range in which the wavelength of the vibrating panels coincides with the trace wavelength of the sound wave causing them to vibrate (they vibrate coincidentally), thus leading to an impairment in the sound insulation. The lowest frequency in which this effect can occur is known as the "coincidence critical frequency" and can be calculated using the following simplified equation [2].

$$f_g = \frac{60}{d} * \sqrt{\frac{\rho}{E_{dyn}}} [Hz]$$

This effect leads to greater sound radiation by the component and thus to an impairment of the sound insulation in the corresponding frequency range. Components with a critical frequency that is either far below or far above the acoustic design frequency range exhibit good soundproofing qualities. Components with a low coincidence critical frequency are referred to as "rigid" whereas thin cladding (plasterboard or gypsum fibreboard) with a high critical frequency is known as "flexible".

3.2. Mass formula for CLT by Stora Enso

For a first estimation, the sound reduction index of a CLT element can be calculated from its mass [3]. The mass of the plate is calculated from thickness and its density in kg/m^3 and is the basis for the equations of the weighted sound reduction index R_w of the CLT plate. Measurements have shown, that the installation angle has an impact on R_w , so two equations have been developed (one for walls and one for floors), taking the most common thicknesses of the particular application into account.

“Mass laws for CLT” is derived from mean values of available measurement results, excluding peculiar outliers. Results are given in separate equations for CLT walls and CLT floors with the respective thicknesses mentioned, for which the equation can be applied to.

$$R_{w,CLT,wall} = 25 \lg(m'_{CLT}) - 8 \text{ in dB}$$

applicable for CLT Walls from 60 to 150 mm

$$R_{w,CLT,floor} = 12,2 \lg(m'_{CLT}) + 15 \text{ in dB}$$

applicable for CLT Floors from 120 to 320 mm

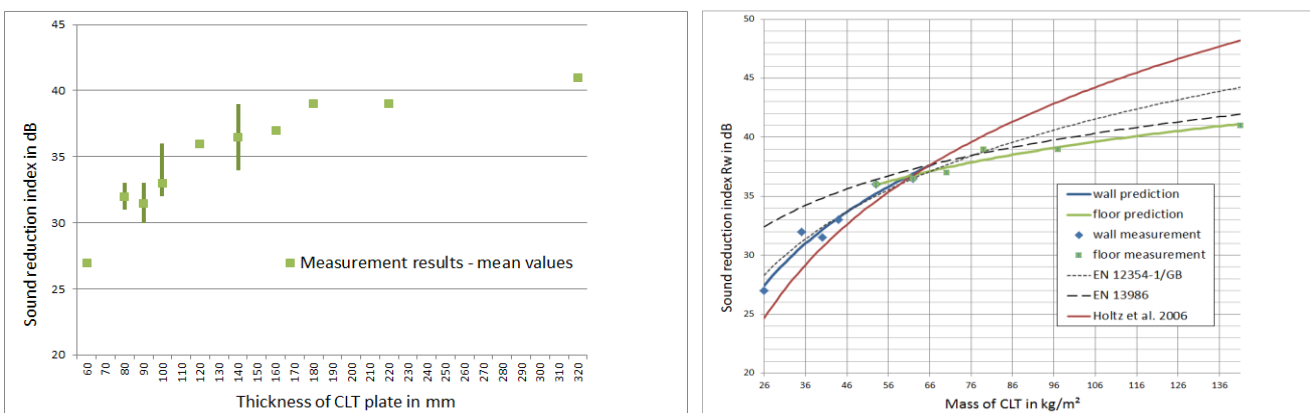

The left figure shows measurement results (mean values and variance) for airborne sound insulation of a CLT plate. The right figure shows the results graphically of the two equations in relation to the measurement results. Standardized equations and calculation model have also been calculated and are pictured as well.

3.3. Orthotropic plates

Because of the crosswise arrangement of the individual layers and the different strength values of wood in the fibre direction or normal to it, CLT also has different strength values along the primary bending axes and can be considered an orthotropic plate (orthogonal-anisotropic). Orthotropic materials differ from isotropic solid components in the sense that they also have different coincidence-induced dips of the sound insulation in different frequency ranges ($f_{c,i}$ and $f_{c,j}$) due to different bending stiffnesses along the primary axes (B_i and B_j). The transmission loss as a function of frequency of a CLT plate without flanking shows no single, strong dip at one coincidence frequency, but a range of increased sound transmission between $f_{c,i}$ and $f_{c,j}$. Depending on the ratio of the two stiffnesses to one another, which depends on the thickness and arrangement of the individual lamellas, this region can extend from a few third-octave bands up to a few octave bands and lead to an increased transmission of sound in this region. The fact that the “coincidence region” of CLT with normal strengths lies in the area relevant to building acoustics, should be taken into account when planning structures.

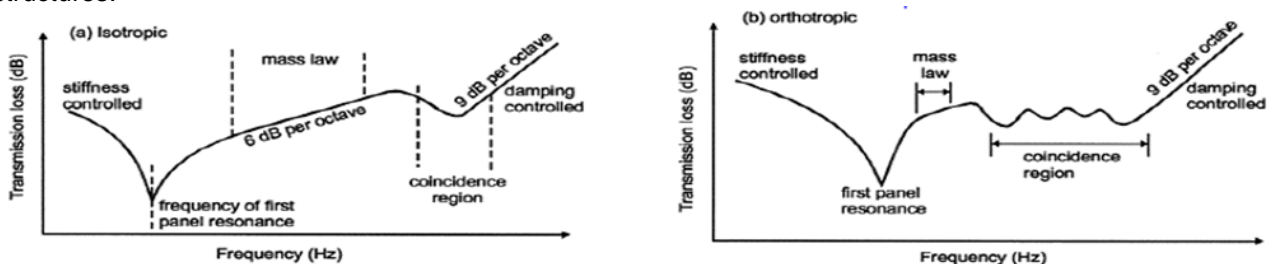

The figure shows the different behaviour of isotropic and orthotropic materials. [4]

3.4. Multi-layer components

The sound insulation behaviour of multi-layer components can be described as a mass-spring system. The mass of the layers and the dynamic stiffness of the intermediate layer determine the position of the resonance frequency which determines the quality of the sound insulation.

If the resonance frequency f_0 is sufficiently low (< 100 Hz), with this type of component, greater sound insulation can be achieved with significantly less mass. The resonance frequency f_0 of two masses with a flexible intermediate layer can be calculated according to [ÖNORM B 8115-4] as follows:

$$f_0 = 160 * \sqrt{s' \left(\frac{1}{m'_1} + \frac{1}{m'_2} \right)} \text{ [Hz]}$$

f_0 resonance frequency in Hz
 m'_1, m'_2 surface-based mass of layers in kg/m^2
 s' dynamic stiffness of intermediate layer (insulation material or air) in MN/m^3

The dynamic stiffness s' of a layer of air is calculated thus:

$$s' = \frac{0,14}{d} \text{ [MN/m}^3\text{]}$$

The dynamic stiffness s' of a sound-absorbing filler is calculated from:

$$s' = \frac{0,111}{d} \text{ [MN/m}^3\text{]}$$

d ... distance between layers in metres

Red Curve: $R_w = 34$ dB

CLT 100 3s (as a non-faced component)

Single-layer structure with coincidence region ($f_{c,i}$ to $f_{c,j}$) of the CLT panel from approx. 125 Hz to 400 Hz, then mass and damping controlled rise in sound insulation by approx. 9 dB per octave. The curve progression in the low frequency range is influenced by the panel's natural vibrations due to the geometry and by the missing diffuse field during the measurements.

Blue Curve: $R_w = 51$ dB

CLT 100 3s with plasterboard mounted on spring hoops

Double-layer structure with resonance frequency f_0 at 80 Hz, then increase in sound insulation by approx. 18 dB per octave, and coincidence critical frequency of the 12.5 mm-thick plasterboard at approx. 2,800 Hz. Due to the mechanically isolated facing panel, the coincidence frequency of the CLT panel at 315 Hz only has little influence. Cavity resonance can be reduced by filling it with mineral wool.

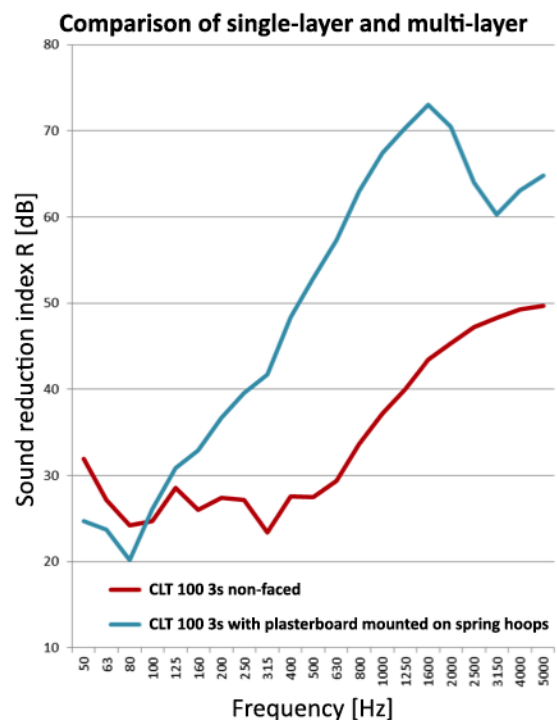

3.5. Prediction model for airborne sound insulation of CLT-walls with ETICS

For this CLT+ETICS (External Thermal Insulation Composite System) model, presented in [3], only measurement data which could provide reliable measured values of the dynamic stiffness of the applied insulation material were used. So, special emphasis was given on material properties of the layers of the investigated building components.

The resonant frequency f_R is calculated, taking the two masses of CLT and the plasterboard as well as the spring (defined by s') of the insulation material into account.

$$f_R = \frac{1}{2\pi} \sqrt{s' * \left(\frac{1}{m'_{CLT}} + \frac{1}{m'_{Putz}} \right)} \quad [Hz]$$

Based on f_R , the R_w of the wall is calculated according to the following equation:

$$R_w = -30 \lg f_R + 110 \quad [dB]$$

Described prediction model for R_w is based on a semiempirical approach with a limited amount of reliable measurements. Thus, it should be improved and extended by adding additional measurements and refining the equation. Nevertheless, accuracy of the model, considering a standard deviation σ of 1.6 and maximum deviations of +2.0 and -2.6 dB, seem to be within common precision of building acoustical applications.

Please note that the use of material data from literature can lead to an over- or underestimation of the sound insulation because the dynamic stiffness of insulation materials can vary significantly also within one type of material. Therefore, always measured data, or data provided from the producer should be used for the calculation.

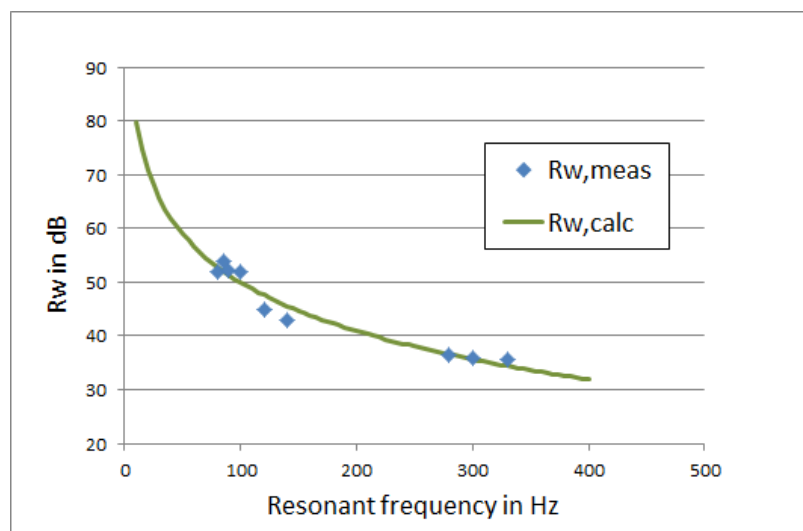

The Figure shows a comparison of measured and calculated weighted sound reduction index R_w of CLT with ETICS

3.6. Sound insulation of composed building components

When a window or door is installed in an external wall, the weighted resulting apparent sound reduction index $R'_{res,w}$ describes the sound insulation of this component.

To determine the performance of the overall soundproofing, the sound reduction index of the individual component surface areas (window, door, wall) and the respective surface area must be taken into account.

The required evaluated sound reduction index of a window $R_{w,F,erf}$ is calculated thus:

$$R_{w,F,erf} = R'_{w,AW} - 10 * \log \left[1 + \frac{S_g}{S_F} * \left(10^{\frac{R'_{w,AW} - R'_{res,w}}{10}} - 1 \right) \right]$$

where the weighted apparent sound reduction index of the external wall is ($R'_{w,AW}$), the required resulting apparent sound reduction index is ($R'_{res,w}$) and the total surface area of the wall is (S_g) and of the window is (S_F).

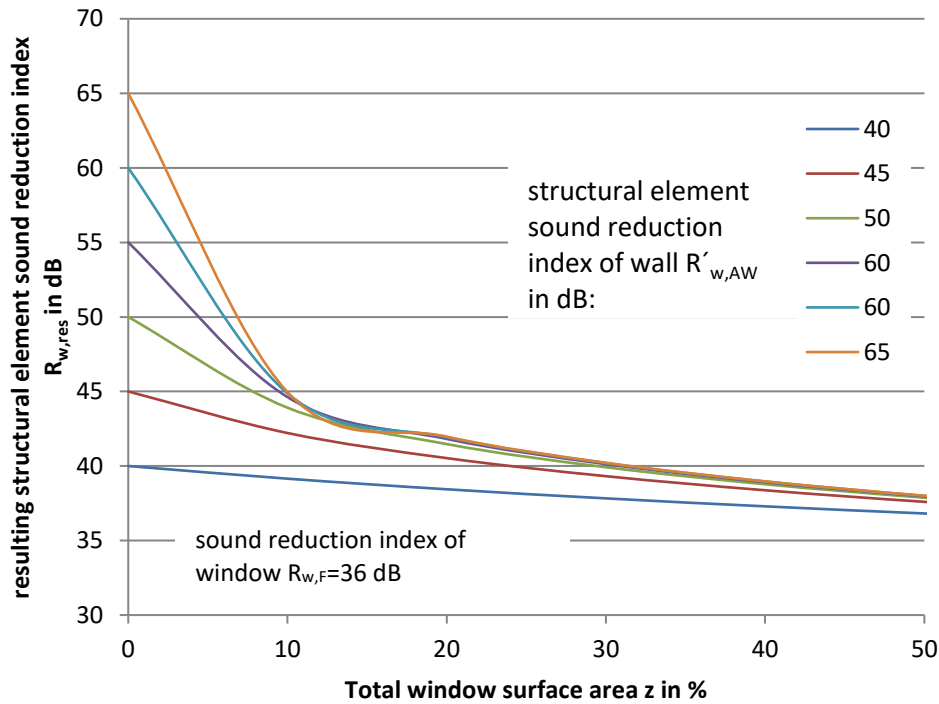

The diagram shows the $R'_{res,w}$ depending on the window surface area when installing a window with $R_{w,F} = 36$ dB.

4. Sound insulation of CLT components

On the following pages examples of floor structures, partition walls, external and internal walls are shown. More build-ups can be found in the building physics chapter of our technical folder (https://issuu.com/storaenso/docs/01_technical_folder_-_stora_ensobu/194) or in the construction catalogue dataholz.com (www.dataholz.com/) or the LIGNUM component catalogue (<http://bauteilkatalog.lignum.ch/>)

4.1. Floor structures

The sound insulation of floor structures can be improved either by increasing the mass or by improving the mechanical isolation of components. In practice, this means installing relatively heavy screed (5–7 cm cement screed; note: the edge insulation strip is not cropped until the flooring has been laid) on a soft impact sound insulation board ($s' \leq 10$) with backfill or bulk to provide additional mass underneath. In the case of non-suspended ceilings, the thickness of the bulk must be increased to approx. 10 cm and, due to its high sound attenuation capacity, the bulk should preferably be un-bonded. The use of loose filling or extremely soft impact sound insulation board should be discussed with the screed installer in advance.

As an alternative to loose filling, elastically-bound filling can be staggered with a latex binder and thus retain its attenuating effect. In terms of sound insulation, ceiling linings are most effective when mechanically isolated (mounted on spring clips or hoops). Cavities should be insulated with mineral wool to prevent cavity resonance. [2]

Floor 1 (thickness 340 mm)

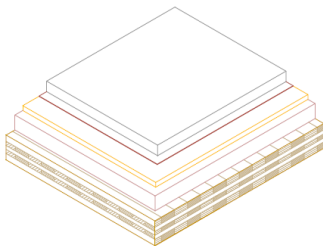

70 mm	cement screed (2200 kg/m ³)
0.2 mm	PE membrane
30 mm	soft impact sound insulation ($s' < 10$ MN/m ³)
100 mm	backfill (elastically bound or installed loose)
140 mm	CLT by Stora Enso

$$R_w(C;C_{tr}) = 63 (-2;-5) \text{ dB} \quad C_{50-3150} = -3 \text{ dB}$$

$$L_{n,w}(C_i) = 43 (-3) \text{ dB} \quad C_{150-2500} = 2 \text{ dB}$$

Floor 2 (thickness 375 mm)

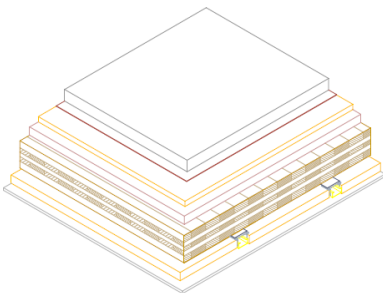

70 mm	cement screed (2200 kg/m ³)
0.2 mm	PE membrane
30 mm	soft impact sound insulation ($s' < 10$ MN/m ³)
50 mm	backfill (loose)
140 mm	CLT by Stora Enso
70 mm	suspension; 60 mm mineral wool
15 mm	plasterboard

$$R_w(C;C_{tr}) = 63 (-2;-6) \text{ dB} \quad C_{50-3150} = -3 \text{ dB}$$

$$L_{n,w}(C_i) = 46 (1) \text{ dB} \quad C_{150-2500} = 9 \text{ dB}$$

Floor 3 (thickness 293 mm)

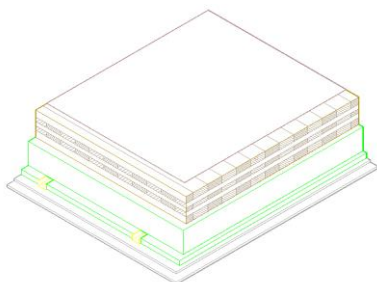

8 mm	PVC floor
160 mm	CLT by Stora Enso
100 mm	Resilient suspension; with mineral wool
12.5 mm	plasterboard
12.5 mm	plasterboard

$$R_w(C;C_{tr}): 65 (-2;-7) \text{ dB} \quad C_{50-3150} = -4 \text{ dB}$$

$$L_{n,w}(C_i): 49 (0) \text{ dB} \quad C_{150-2500} = 5 \text{ dB}$$

4.2. Wall structures

While the soundproofing of single-layer components is determined by their surface-based mass and flexural rigidity, where multi-layer panels are concerned, greater soundproofing can be achieved with less mass. Resonance frequency can be reduced by increasing the gaps between the layers, increasing the mass of the individual layers and ensuring that facing panels are attached as flexibly as possible to the load-bearing wall. To avoid cavity resonance, the facing panels should be filled with fibrous sound-absorbing insulation material.

4.2.1. Partition walls

Details about the construction of connection nodes are available on request.

Partition wall 1

(thickness 390 mm)

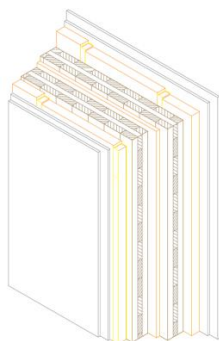

12.5 mm	plasterboard
12.5 mm	plasterboard
50 mm	separate facing panel including 50 mm mineral wool
100 mm	CLT by Stora Enso
40 mm	mineral wool
100 mm	CLT by Stora Enso
50 mm	separate facing panel including 50 mm mineral wool
12.5 mm	plasterboard
12.5 mm	plasterboard

$D_{nT,w} (C;C_{tr})$: 67 (-1;-4) dB
 $C_{50-3150} = -9$ dB

Partition wall 2

(thickness 270 mm)

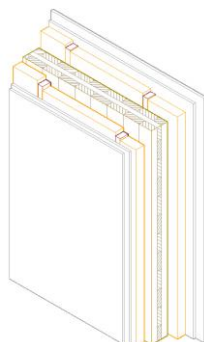

12.5 mm	sound rated plasterboard
12.5 mm	sound rated plasterboard
65 mm	independent studs held 15mm clear from CLT with 50mm mineral fibre in stud cavity
90 mm	CLT by Stora Enso
65 mm	independent studs held 15mm clear from CLT with 50mm mineral fibre in stud cavity
12.5 mm	sound rated plasterboard
12.5 mm	sound rated plasterboard

$D_{nT,w} (C;C_{tr})$: 67 (-2;-7) dB*
 $C_{50-3150} = -11$ dB*

* lowest value out of 4 site measurements

Partition wall 3

(thickness 305 mm)

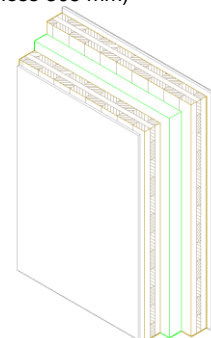

12.5 mm	plasterboard
100 mm	CLT by Stora Enso
60-80 mm	mineral wool
100 mm	CLT by Stora Enso
12.5 mm	plasterboard

$R'_w (C;C_{tr})$: 58 (-1;-6) dB*
 $C_{50-3150} = -2$ dB*

* lowest value out of 6 site measurements

4.2.2. External walls

External wall 1

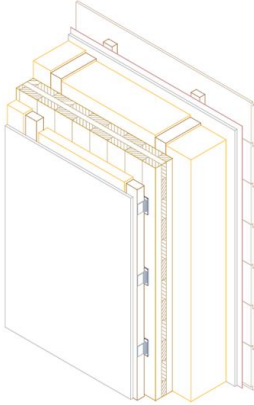

- 20 mm wooden cladding
- 30 mm wooden battens (30/50)
- < 1 mm vapour - permeable membrane
- 15 mm gypsum fibre board
- 200 mm solid timber beams (200/60, e= 62,5cm), filled with
 - a.: hemp-fibre insulation
 - b.: wood fibre insulation
- > 90 mm **CLT by Stora Enso**
- 70 mm wooden battens (60/60), mounted on resilient clips
the space between is filled with 50mm mineral wool
- 12.5 mm gypsum plasterboard

a.: $R_w (C;C_{tr})$: 51 (-2;-7) dB (with hemp fiber insulation)

b.: $R_w (C;C_{tr})$: 53 (-2;-8) dB (with wood fiber insulation)

External wall 2

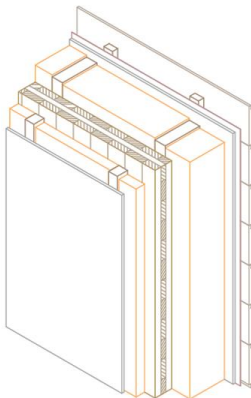

- 20 mm wooden cladding
- 30 mm wooden battens (30/50)
- < 1 mm vapour - permeable membrane
- 15 mm gypsum fibre board
- 200 mm solid timber beams (200/60, e= 62,5cm), filled with hemp-fibre insulation material
- > 90 mm **CLT by Stora Enso**
- 60 mm wooden battens (60/60),
the space between is filled with 50mm mineral wool
- 12.5 mm gypsum plasterboard

$R_w (C;C_{tr})$: 46 (-2;-5) dB

External wall 3

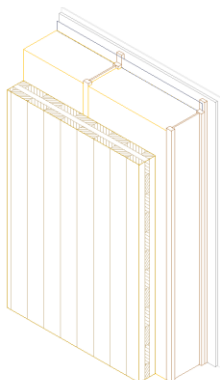

- 5 mm mineral plaster
- 12.5 mm cement-bound lightweight concrete panel
- 30 mm open boarding
- < 1 mm vapour - permeable membrane
- 200 mm timber/timber material beam,
with 200 mm wood-fibre insulation
- > 80 mm **CLT by Stora Enso**

$R_w (C;C_{tr})$: 43 (-2;-7) dB

4.2.3. Internal walls

Even if there are no specific soundproofing requirements for individual rooms within an apartment, sound insulation should still be borne in mind when planning buildings to provide protection against noise. Improvements to the soundproofing of internal walls, such as mounting facing panels, should be made in noisy areas as this helps to reduce the transmission of sound into the structure and lowers the proportion of flanking sound.

The sound insulation of a 100 mm-thick CLT wall with different types of cladding was tested in a series of measurements in the laboratory for building physics at the Technical University of Graz.

CLT non-faced wall

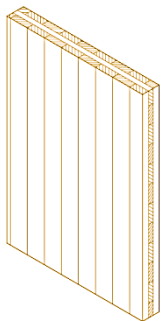

100 mm **CLT by Stora Enso**

 $R_w (C;C_{tr}): 34 (-1;-3) \text{ dB}$
 $C_{50-3150}: -1 \text{ dB}$

Spring clip

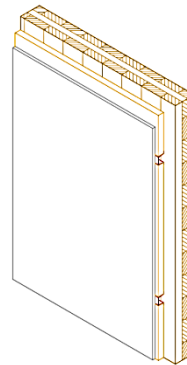

100 mm **CLT by Stora Enso**
27 mm spring clip with an intermediate layer of mineral wool (50 mm compressed to 27 mm)
12.5 mm fire-protection plasterboard

 $R_w (C;C_{tr}): 48 (-5;-12) \text{ dB}$
 $C_{50-3150}: -5 \text{ dB}$

Fire protection plaster board on one side

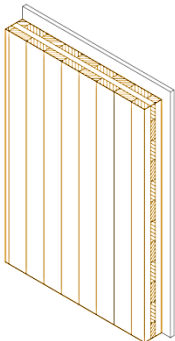

100 mm **CLT by Stora Enso**
12.5 mm fire-protection plasterboard

 $R_w (C;C_{tr}): 37 (-1;-3) \text{ dB}$
 $C_{50-3150}: -1 \text{ dB}$

Spring hoop

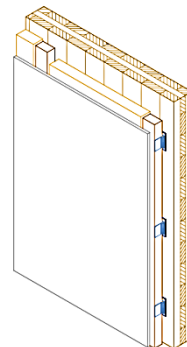

100 mm **CLT by Stora Enso**
3 mm joint sealing tape
50 mm wooden batten on spring clip with an intermediate layer of mineral wool
12.5 mm fire-protection plasterboard

 $R_w (C;C_{tr}): 51 (-2;-8) \text{ dB}$
 $C_{50-3150}: -4 \text{ dB}$

Fire protection plaster board on both sides

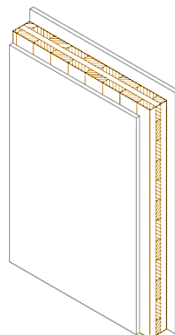

2.5 mm fire-protection plasterboard
100 mm **CLT by Stora Enso**
12.5 mm fire-protection plasterboard

 $R_w (C;C_{tr}): 37 (-1;-3) \text{ dB}$
 $C_{50-3150}: -1 \text{ dB}$

Wooden battens

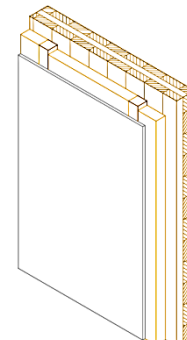

100 mm **CLT by Stora Enso**
50 mm wooden batten with an intermediate layer of mineral wool
12.5 mm fire-protection plasterboard

 $R_w (C;C_{tr}): 45 (-1;-5) \text{ dB}$
 $C_{50-3150}: -2 \text{ dB}$

1.1. Roof structures

In modern office and residential buildings, flat roofs are sometimes used as terraces and roof top spaces. When planning a roof terrace, it's important to not only meet the requirements of thermal insulation, but also airborne and impact sound insulation. A regular roof usually doesn't require impact sound insulation but when a flat roof is used as a terrace, impact sound insulation is key to protect the occupants from noise pollution. There are not many guidelines on how to soundproof roof structures. To help give good advice on the matter, Stora Enso have tested some roof structures in acoustic laboratories.

1.1.1. Examples for roof structures:

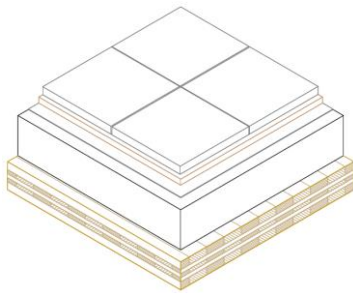

40 mm paving slab
 30 mm macadam
 2.5 mm EPDM rubber roofing
 200 mm EPS insulation
 140 mm **CLT by Stora Enso**

$R_w(C;C_{tr}) = 53 (-2;-6) \text{ dB}$
 $L_{n,w}(C_i) = 58 (2) \text{ dB}$

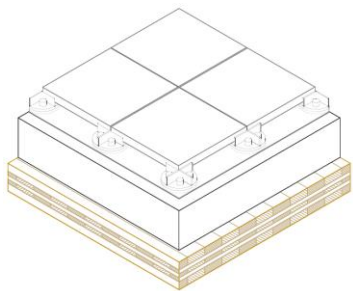

40 mm paving slab
 40 mm paving slab supports
 12 mm levelling pads, sylomer
 2.5 mm roofing membrane
 200 mm EPS insulation
 140 mm **CLT by Stora Enso**

$R_w(C;C_{tr}) = 38 (-1;-4) \text{ dB}$
 $L_{n,w}(C_i) = 52 (-1) \text{ dB}$

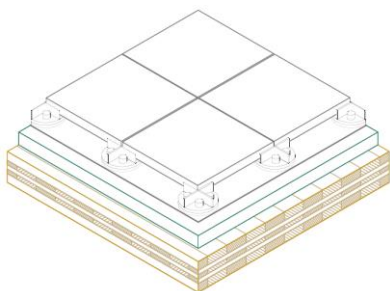

40 mm paving slab
 40 mm paving slab supports
 12 mm levelling pads, sylomer
 2.5 mm roofing membrane
 58 mm vacuum insulation panel
 140 mm **CLT by Stora Enso**

$R_w(C;C_{tr}) = 37 (-1;-5) \text{ dB}$
 $L_{n,w}(C_i) = 55 (-3) \text{ dB}$

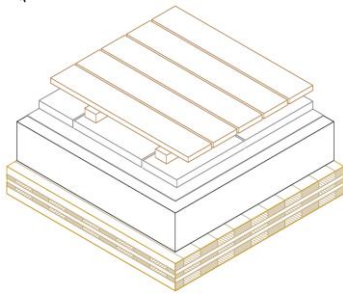

26 mm decking boards
 44 mm wooden battens
 12 mm levelling pads, sylomer
 40 mm paving slabs and macadam
 2.5 mm EPDM roofing membrane
 200 mm EPS insulation
 140 mm **CLT by Stora Enso**

$R_w(C;C_{tr}) = 51 (-1;-5) \text{ dB}$
 $L_{n,w}(C_i) = 45 (1) \text{ dB}$

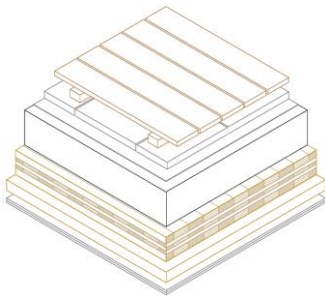

26 mm decking boards
 44 mm wooden battens
 12 mm levelling pads, sylomer
 40 mm paving slabs and macadam
 2.5 mm EPDM roofing membrane
 200 mm EPS insulation
 140 mm **CLT by Stora Enso**
 60 mm mineral wool insulation
 90 mm decoupling fastner, CD-profile
 2 x 12.5 mm gypsum plasterboard

$R_w(C;C_{tr}) = 72 (-5;-13) \text{ dB}$
 $L_{n,w}(C_i) = 45 (1) \text{ dB}$

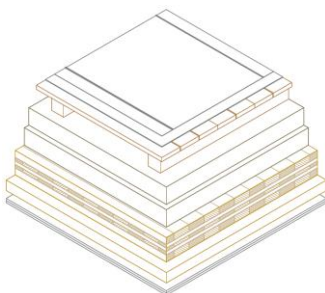

0.5 mm aluminium roof
 3 mm bitumen membrane
 24 mm decking boards
 80 mm wooden battens
 2 x 100 mm wood fibre insulation panels
 140 mm **CLT by Stora Enso**
 60 mm mineral wool insulation
 90 mm decoupling fastner, CD-profile
 2 x 12.5 mm gypsum plasterboard

$R_w(C;C_{tr}) = 71 (-5;-13) \text{ dB}$

5. Sound transmission in buildings

In addition to the sound path directly above the partition assembly, several sound transmission pathways also exist, depending on the design, and these are referred to as flanks.

As the soundproofing requirements of individual countries consist of the sound insulation and transmission pathways, in addition to the partition assembly, the flanking components must also be taken into account. Thus it is important to note that the better the quality of the partition assembly, the greater the proportion of flanking sound in the overall transmission of sound. Flanking sound can be reduced either by mechanically isolating the components (e.g. with elastomers) or by mounting flexible facing panels.

Planning principles related to the requirements for elastic bearings have been published by Holzforschung Austria in [2], part of which is described in the annex to this document.

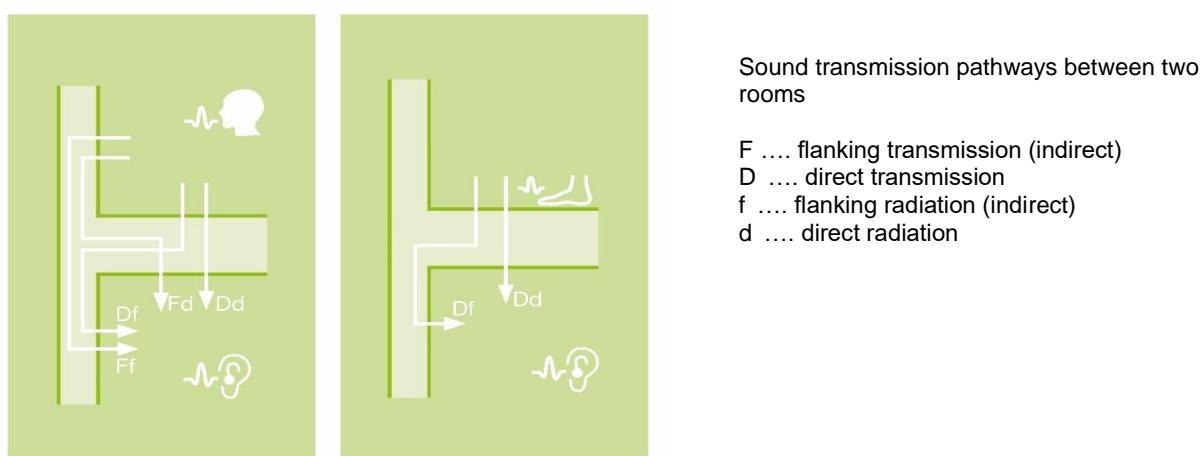

In principle, soundproofing can be verified either mathematical, based on the calculation method in EN 12354, or through metrological measurements, based on construction site measurements. Despite active research and a few early publications, no sufficiently accurate values for the relatively new product, cross-laminated timber, exist as yet to enable a calculation to be performed in line with EN 12354. Simplified calculation approaches for sound transmission in solid wood construction can be found, for example, in the publications of the Informationsdienst Holz [3] or the Holzforschung Austria [4].

In the meantime, many well-documented construction site measurements are available upon request and can be referred to during verifications.

Bibliography

- [1] B. Rasmussen and M. Machimbarrena, "Existing sound insulation performance requirements and classification schemes for housing across Europe," in *COST Action TU0901 – Building acoustics throughout Europe. Volume 1: Towards a common framework in building acoustics throughout Europe*, 2014.
- [2] M. TEIBINGER, I. MATZINGER and F. DOLEZAL, Bauen mit Brettsperrholz im Geschoßbau - Focus Bauphysik, Planungsbroschüre, Holzforschung Austria, Wien, 2013.
- [3] F. Holtz, J. Hessinger, H. P. Buschbacher and A. Rabold, "Schalldämmende Holzbalken- und Brettstapeldecken," in *Informationsdienst Holz - Holzbauhandbuch Reihe 3 Teil 3 Folge 3*, München, Entwicklungsgemeinschaft Holzbau (EGH), 1999.
- [4] M. Teibinger, F. Dolezal and I. Matzinger, Deckenkonstruktionen für den mehrgeschoßigen Holzbau - Schall- und Brandschutzl, Wien: Holzforschung Austria, 2009.

Annex A: Comparison of minimum requirements in 35 European countries [1]

Airborne sound (status June 2013)		Residential buildings	Terraced housing
Country	Descriptor	Req. [dB]	Req. [dB]
Austria	DnT,w	≥ 55	≥ 60
Belgium	DnT,w	≥ 54	≥ 58
Bulgaria	R'w	≥ 53	≥ 53
Croatia	R'w	≥ 52	≥ 52
Cyprus	N/A	N/A	N/A
Czech Republic	R'w	≥ 53	≥ 57
Denmark	R'w	≥ 55	≥ 55
England & Wales	DnT,w + Ctr	≥ 45	≥ 45
Estonia	R'w	≥ 55	≥ 55
Finland	R'w	≥ 55	≥ 55
France	DnT,w + C	≥ 53	≥ 53
Germany	R'w	≥ 53	≥ 57
Greece	R'w	≥ 50	≥ 50
Hungary	R'w + C	≥ 51	≥ 56
Iceland	R'w	≥ 55	≥ 55
Ireland	DnT,w	≥ 53	≥ 53
Italy	R'w	≥ 50	≥ 50
Latvia	R'w	≥ 54	≥ 54
Lithuania	DnT,w or R'w	≥ 55	≥ 55
Luxembourg	N/A	N/A	N/A
Macedonia FYR	N/A	N/A	N/A
Malta	N/A	N/A	N/A
Netherlands	R'w + C	≥ 52	≥ 52
Norway	R'w	≥ 55	≥ 55
Poland	R'w + C	≥ 50	≥ 52
Portugal	DnT,w	≥ 50	≥ 50
Romania	R'w	≥ 51	≥ 51
Scotland	DnT,w	≥ 56	≥ 56
Serbia	R'w	≥ 52	≥ 52
Slovakia	R'w or DnT,w	≥ 53	≥ 57
Slovenia	R'w	≥ 52	≥ 52
Spain	DnT,A ≈ DnT,w + C	≥ 50	≥ 50
Sweden	DnT,w + C50-3150	≥ 52	≥ 52
Switzerland	DnT,w + C	≥ 52	≥ 55
Turkey	N/A	N/A	N/A

Impact sound (status June 2013)		Residential buildings	Terraced housing
Country	Descriptor	Req. [dB]	Req. [dB]
Austria	L'nT,w	≤ 48	≤ 43
Belgium	L'nT,w	≤ 58	≤ 50
Bulgaria	L'n,w	≤ 53	≤ 53
Croatia	L'w	≤ 68	≤ 68
Cyprus	N/A	N/A	N/A
Czech Republic	L'n,w	≤ 55	≤ 48
Denmark	L'n,w	≤ 53	≤ 53
England & Wales	L'nT,w	≤ 62	none
Estonia	L'n,w	≤ 53	≤ 53
Finland	L'n,w	≤ 53	≤ 53
France	L'nT,w	≤ 58	≤ 58
Germany	L'n,w	≤ 53	≤ 48
Greece	L'n,w	≤ 60	≤ 60 Info
Hungary	L'n,w	≤ 55	≤ 45
Iceland	L'n,w	≤ 53	≤ 53
Ireland	L'nT,w	≤ 62	None
Italy	L'n,w	≤ 63	≤ 63
Latvia	L'n,w	≤ 54	≤ 54
Lithuania	L'n,w	≤ 53	≤ 53
Luxembourg	N/A	N/A	N/A
Macedonia FYR	N/A	N/A	N/A
Malta	N/A	N/A	N/A
Netherlands	L'nT,w + CI	≤ 54	≤ 54
Norway	L'n,w	≤ 53	≤ 53
Poland	L'n,w	≤ 58	≤ 53
Portugal	L'nT,w	≤ 60	≤ 60
Romania	L'n,w	≤ 59	≤ 59
Scotland	L'nT,w	≤ 56	none
Serbia	L'n,w	≤ 68	≤ 68
Slovakia	L'n,w or L'nT,w	≤ 55	≤ 48
Slovenia	L'n,w	≤ 58	≤ 58
Spain	L'nT,w	≤ 65	≤ 65
Sweden	L'nT,w + CI,50-2500	≤ 56	≤ 56
Switzerland	L'nT,w + CI	≤ 53	≤ 50
Turkey	N/A	N/A	N/A

Annex B: Planning principles related to the requirements for elastic bearings [2]

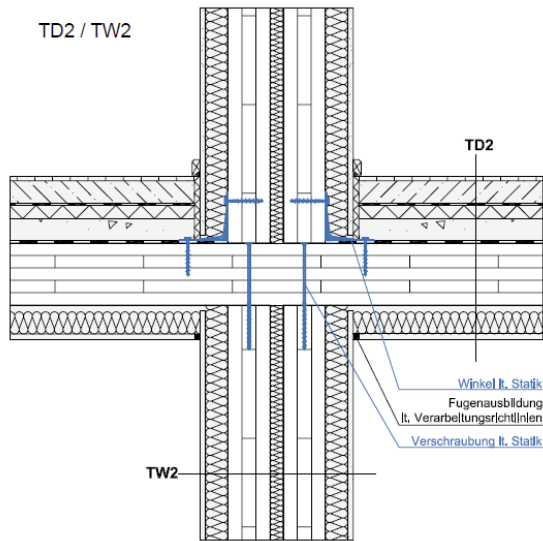

No bearings are required in the case of suspended ceilings and mechanically-isolated facing panels.

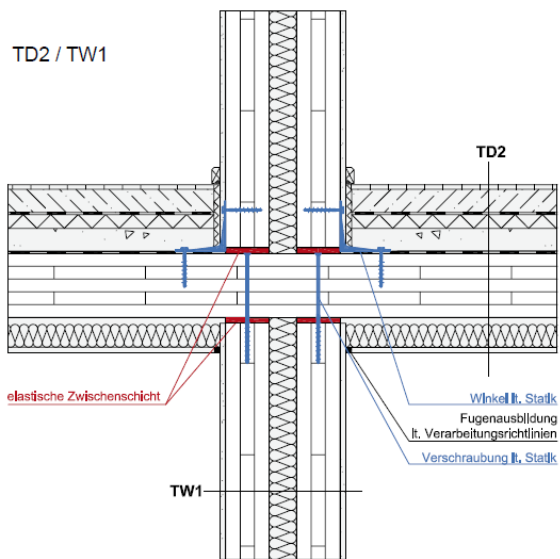

Elastic bearings are required **above and below the ceiling** in the case of suspended ceilings without mechanically-isolated facing panels on the walls.

TD1 / TW2

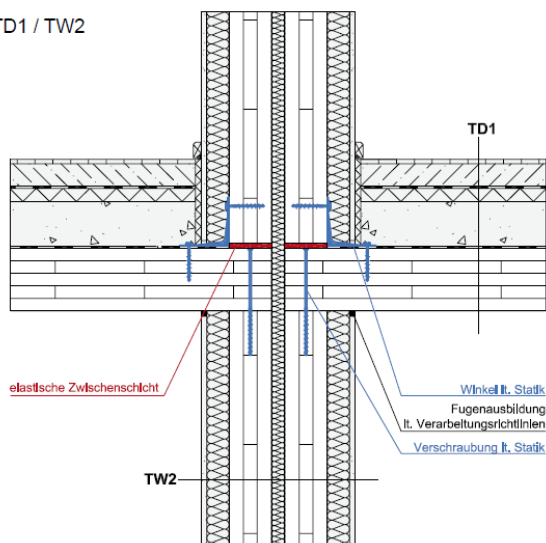

Elastic bearings are required **above the ceiling** in the case of cross-laminated timber ceilings with a timber soffit (without a suspended ceiling) and mechanically-isolated facing panels on the walls.

TD1 / TW1

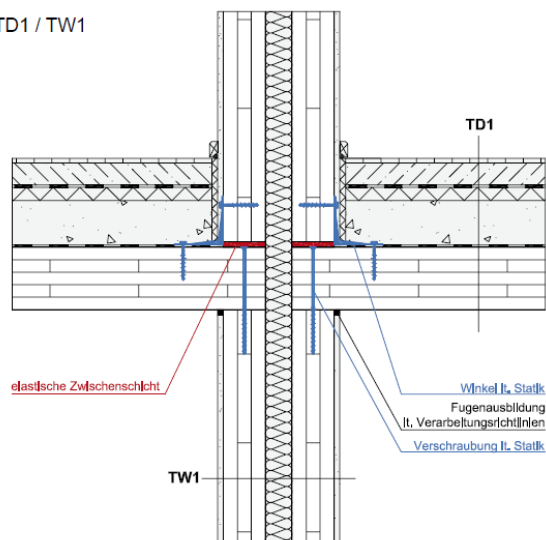

Elastic bearings are required **above the ceiling** in the case of cross-laminated timber ceilings with a timber soffit (without a suspended ceiling) and without mechanically-isolated facing panels on the walls.

TD2 / TW3

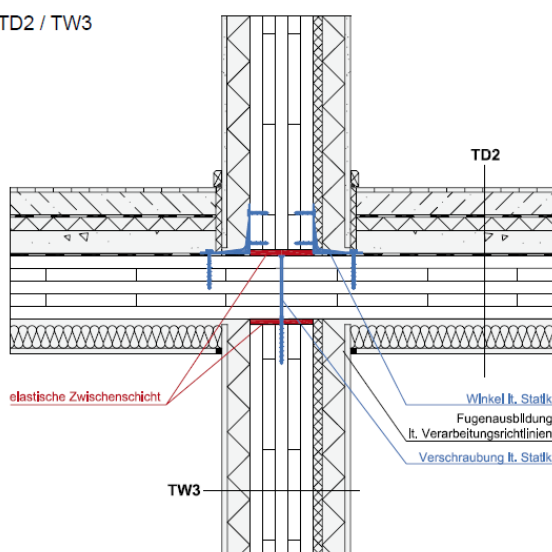

Mechanically-isolated facing panels, suspended ceilings and elastic bearings above and below the ceiling are always required on continuous ceilings above different parts of the building.



Stora Enso
Division Wood Products

Building Solutions
E-Mail: buildingsolutions@storaenso.com
www.storaenso.com
facebook.com/storaensolivingroom